

IMPERIAL

Compression (%)	15.0	20.0	22.5	25.0	27.5
Load (lbs.)	140	205	240	275	320
Height (in.)	2.98	2.80	2.71	2.63	2.54
Rate (lbs./in.)	310	360	420	500	580
Effective Deflection (in.)	0.45	0.57	0.57	0.55	0.55
Natural Freq. (CPM)	280	249	249	253	253
Maximum OD (in.)	2.5				
Weight (lbs.)	0.24				

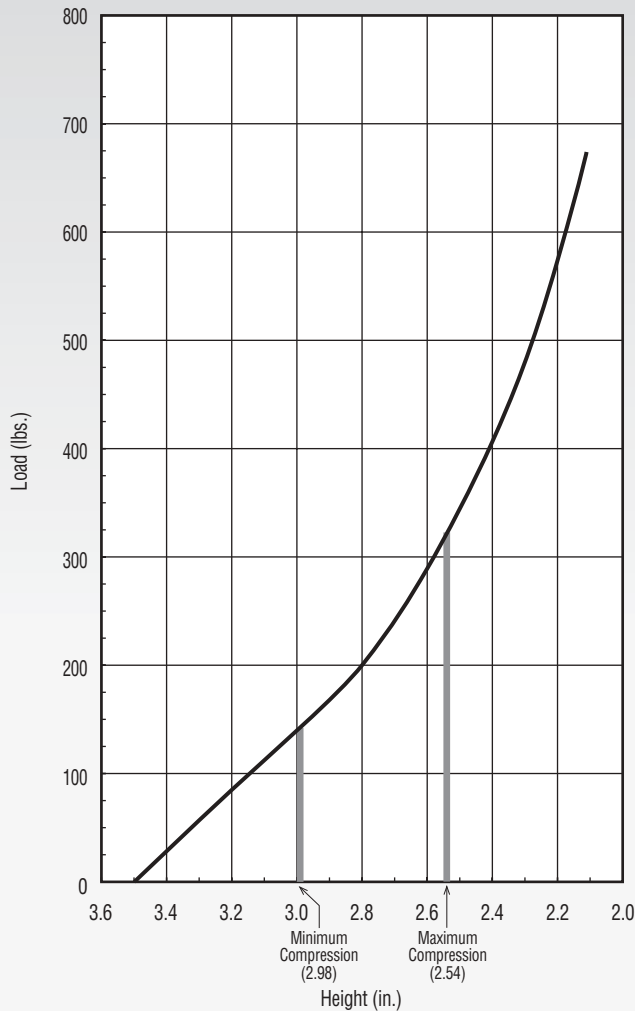
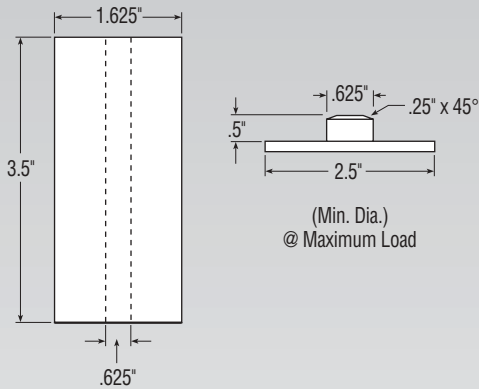

METRIC

Compression (%)	15.0	20.0	22.5	25.0	27.5
Load (kN)	0.62	0.91	1.07	1.22	1.42
Height (mm)	76	71	69	67	64
Rate (kN/m)	54	63	73	87	101
Effective Deflection (mm)	11	14	15	14	14
Natural Freq. (Hz)	4.66	4.15	4.15	4.22	4.22
Maximum OD (mm)	64				
Weight (kg)	0.11				

