

007 - A MODERN TOOL FOR



REPLACES BLOWING GUNS WITHOUT NOZZLES

With blowing pipe diameters 3 - 4 mm
1/8"

BENEFITS

- Noise reduction – Halves the noise level
- Air consumption reduction – 20 - 50%
- Safety nozzle – Meets OSHA standards

The valve design of the Silvent 007 represents an innovative breakthrough in the design of blowing guns. Its two-step system reduces noise levels and energy consumption considerably.

VARIABLE POSITION, the gun's first step, is fully adequate for the majority of tasks. This position allows variable adjustment of the blowing force, thereby consuming only the amount of air necessary for each operation. In most cases the 007 gets the job done at a sound level of just 75 dB(A) and with an energy savings of up to 50%.

BOOSTER POSITION, the gun's second step, doubles the blowing force and provides the increased output that is necessary for the most demanding operations. In addition, the 007 offers features such as:

TOP AND BOTTOM SUPPLY CONNECTION, **SOFTGRIP HANDLE**, and a **STAINLESS STEEL LOW NOISE NOZZLE**- a stainless steel nozzle that is capable of withstanding heavy mechanical wear and that fulfills OSHA safety requirements, which stipulate that air pressure must not exceed 210 kPa (30 psi) in direct contact with skin. Patented.

DIMENSIONS

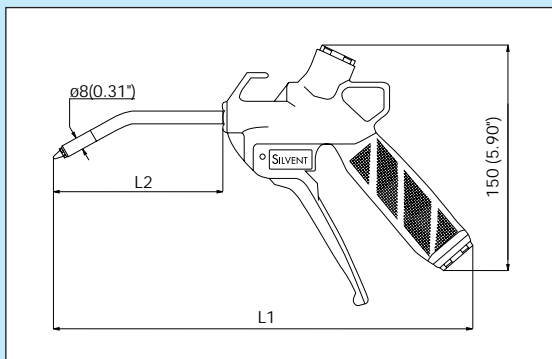

AIR CONE PATTERN

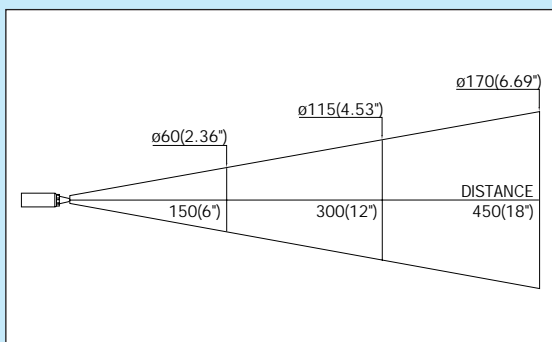

PRODUCT INFORMATION

| ORDER NO./ MODEL | 007 | 007-250 | 007-400 | 007-600 | 007-800 | 007-1000 |
|------------------|------|---------|---------|---------|---------|----------|
| Nozzle | 0071 | 0071 | 0071 | 0071 | 0071 | 0071 |
| L1 | mm | 246 | 393 | 543 | 743 | 943 |
| | " | 9.69 | 15.47 | 21.38 | 29.25 | 37.13 |
| L2 | mm | 103 | 250 | 400 | 600 | 800 |
| | " | 4.06 | 9.84 | 15.75 | 23.62 | 31.50 |

| | | | | | | |
|-----------------------------------|--------------------|---------|---------|---------|---------|---------|
| Replaces open pipe | mm | 4 | 4 | 4 | 4 | 4 |
| | " | 1/8 | 1/8 | 1/8 | 1/8 | 1/8 |
| Air consumption variable position | Nm ³ /h | 11 | 11 | 11 | 11 | 11 |
| | scfm | 6.5 | 6.5 | 6.5 | 6.5 | 6.5 |
| Air consumption booster position | Nm ³ /h | 16 | 16 | 16 | 16 | 16 |
| | scfm | 9.4 | 9.4 | 9.4 | 9.4 | 9.4 |
| Sound level variable | dB(A) | 75 | 75 | 75 | 75 | 75 |
| Sound level booster | dB(A) | 81 | 81 | 81 | 81 | 81 |
| Blowing force variable position | N | 1.6 | 1.6 | 1.6 | 1.6 | 1.6 |
| | oz | 5.6 | 5.6 | 5.6 | 5.6 | 5.6 |
| Blowing force booster position | N | 2.8 | 2.8 | 2.8 | 2.8 | 2.8 |
| | oz | 9.9 | 9.9 | 9.9 | 9.9 | 9.9 |
| Max. temp. | °C | -20/+70 | -20/+70 | -20/+70 | -20/+70 | -20/+70 |
| | °F | -4/+158 | -4/+158 | -4/+158 | -4/+158 | -4/+158 |
| Weight | g | 205 | 245 | 285 | 330 | 375 |
| | lbs | 0.45 | 0.54 | 0.63 | 0.73 | 0.82 |
| Connection | BSP | 1/4" | 1/4" | 1/4" | 1/4" | 1/4" |
| | NPT | 1/4"-18 | 1/4"-18 | 1/4"-18 | 1/4"-18 | 1/4"-18 |
| Nozzle material | Stainless steel | | | | | |

Further information in: Technical specifications.

Max. operating pressure: 1.0 MPa (143 psi)

SAFE AND EFFICIENT BLOWING

Standard variations of the 007

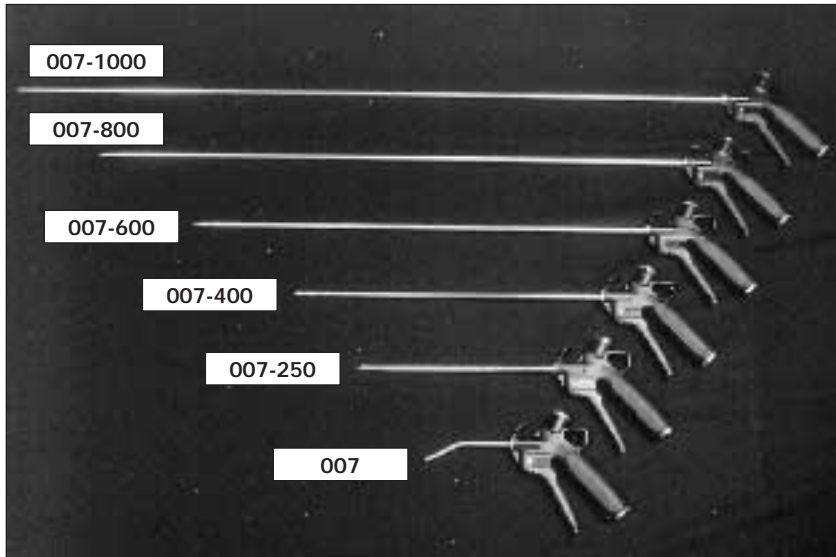

The 007 series is available in 6 different standard lengths. Every gun is fitted with a stainless steel low noise nozzle. Other lengths and nozzles are available upon request. Every model fully meets OSHA safety standards.

BLOWING GUN 007-Z



Blowing pistol 007-Z is fitted with a zinc nozzle instead of the stainless steel nozzle that is standard on the 007 guns. These guns are suitable for applications where there is little or no mechanical wear on the nozzle within, for example, the textile industry, the wood working industry, etc. In other respects, performance equivalent to the 007. The 007-Z is available in the same lengths and variations as the 007. Meets OSHA safety standards.

ACCESSORIES



Silvent's blowing guns can easily be fitted with a transparent safety shield. The shield effectively protects the eyes and body against flying debris encountered in, for instance, hole blowing. Shield size = Ø 100 mm (4").

Order number: 590



Silvent offers a large assortment of self-coiling spiral hoses. The hoses are available in three different materials and have been pressure drop tested for optimum compatibility with Silvent's blowing nozzles.

Further information in: Accessories.

SPARE PARTS

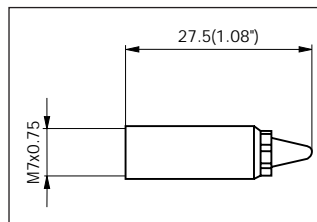

Nozzle 0071

Stainless steel nozzle. This nozzle is suitable for the 007 series guns and the 500-S.

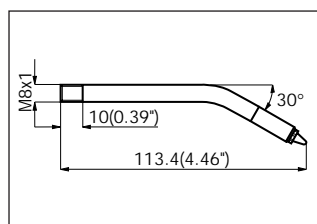

Blowing pipe 0072

Complete blowing pipe including stainless steel nozzle 0071. For the 007 gun and the 500-S.

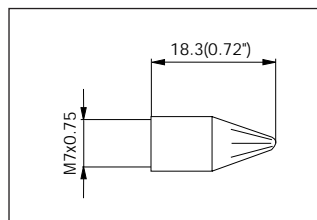

Nozzle 5001

Nozzle in zinc. Used on the 007-Z and 500 gun.

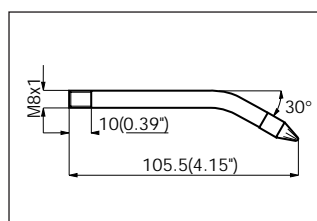

Blowing pipe 5002

Complete blowing pipe including zinc nozzle 5001. Suitable for the 007-Z and 500 gun.